

DI16 080M. 405 kW (550 hp)

US Tier 3, IMO Tier II, CCNR II



The marine engines from Scania are based on a robust design with a strength optimised cylinder block containing wet cylinder liners that can easily be exchanged. Individual cylinder heads with 4 valves per cylinder promotes reparability and fuel economy. The engines are type approved in all major classification societies.

The engine is equipped with a Scania developed Engine Management System, EMS, in order to ensure the control of all aspects related to engine performance. The injection system is based on electronically controlled unit injectors that gives low exhaust emissions with good fuel economy and a high torque already at low revs. The engine can be fitted with many accessories such as air cleaners, PTOs, transmissions and type approved instrumentation in order to suit a variety of installations.

	Rating	Engine speed (rpm)		
		1200	1500	1800
Gross power, full load (kW)	ICFN	325	385	405
Gross power, full load (hp, metric)		442	523	550
Gross power, propeller curve (kW)		147	257	405
Gross power, propeller curve (hp, metric)		200	349	550
Gross torque (Nm)		2586	2450	2149
Spec fuel consumption. Full load (g/kWh)		205	205	216
Spec fuel consumption. 3/4 load (g/kWh)		206	207	224
Spec fuel consumption. 1/2 load (g/kWh)		205	212	231
Spec fuel consumption. Propeller curve (l/h)		36	64	104
Optimum fuel consumption (g/kWh)		198		
Heat rejection to coolant (kW)		260	301	344

ICFN - Continuous service: Rated power available 1 h/1 h. Unlimited h/year service time at a total load factor of 100%.

Standard equipment

- Scania Engine Management System, EMS
- Unit injectors, PDE
- Twin turbochargers, heat insulated
- Fuel pre-filter with water separator
- Fuel filter
- Oil filter, full flow
- Centrifugal oil cleaner
- Oil cooler, integrated in block
- Oil filler, in valve cover
- Deep front oil sump
- Oil dipstick, front
- Starter, 2-pole 7.0 kW
- Alternator, 2-pole 100A
- Flywheel SAE 14
- Silumin flywheel housing, SAE 1 flange
- Front-mounted engine brackets
- Catwalk and cover for belt transmission
- Closed crankcase ventilation
- Operator's manual

Engines with heat exchanger:

- Sea water pump
- Dual heat exchangers with expansion tanks

Optional equipment

- Electrical base system
- Accelerator position sensor
- Control panel
- Instrument panel
- Scania EMS display
- Hydraulic pump
- Side-mounted PTO
- Front-mounted PTO
- Exhaust connections
- Engine heater
- Power pack engine brackets
- Stiff rubber suspension
- Air cleaner
- Studs in flywheel housing
- Reversible fuel filter
- Low coolant level reaction
- Variable idle speed setting
- Low oil sump
- Oil draining with pump
- Oil level sensor
- Bilge pump

This specification may be revised without notice.



DI16 080M. 405 kW (550 hp)

US Tier 3, IMO Tier II, CCNR II

Engine description

No of cylinders	V 8
Working principle	4-stroke
Firing order	1 - 5 - 4 - 2 - 6 - 3 - 7 - 8
Displacement	16.4 litres
Bore x stroke	130 x 154 mm
Compression ratio	16.7:1
Weight	1670 kg (excl oil and coolant)
Piston speed at 1500 rpm	7.7 m/s
Piston speed at 1800 rpm	9.24 m/s
Camshaft	High position alloy steel
Pistons	Steel pistons
Connection rods	I-section press forgings of alloy steel
Crankshaft	Alloy steel with hardened and polished bearing surfaces
Oil capacity	40-48 dm ³ (standard oil sump)
Electrical system	2-pole 24V

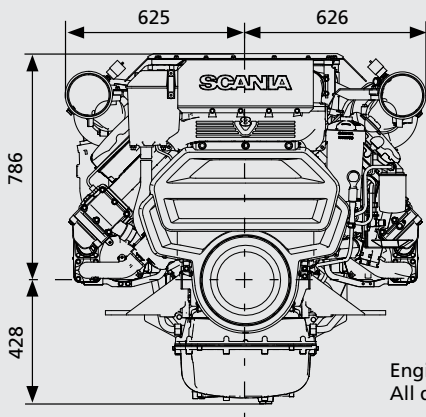
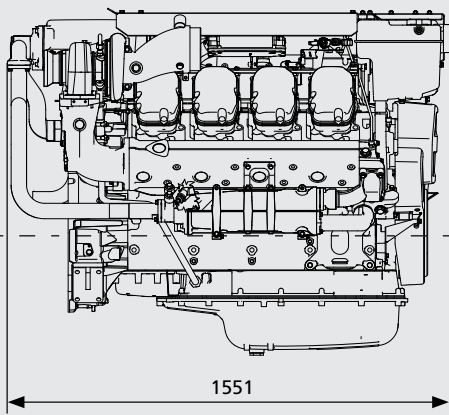

Engine with heat exchanger
All dimensions in mm

Output

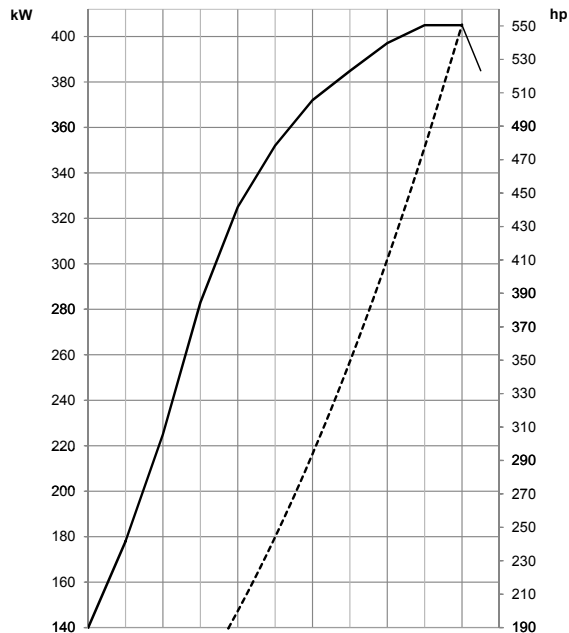

Torque

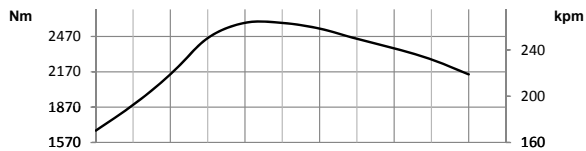

Spec fuel consumption

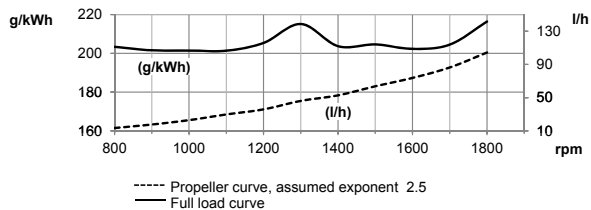

Test conditions Air temperature +25°C. Barometric pressure 100 kPa (750 mmHg). Humidity 30%. Diesel fuel acc. to ECE R 24 Annex 6. Density of fuel 0.840 kg/dm³. Viscosity of fuel 3.0 cSt at 40°C. Energy value 42700 kJ/kg. Power test code ISO 3046. Power and fuel values +/-3%.



SCANIA

SE 151 87 Södertälje, Sweden
Telephone +46 8 553 810 00
Telefax +46 8 553 829 93
www.scania.com
engines@scania.com