

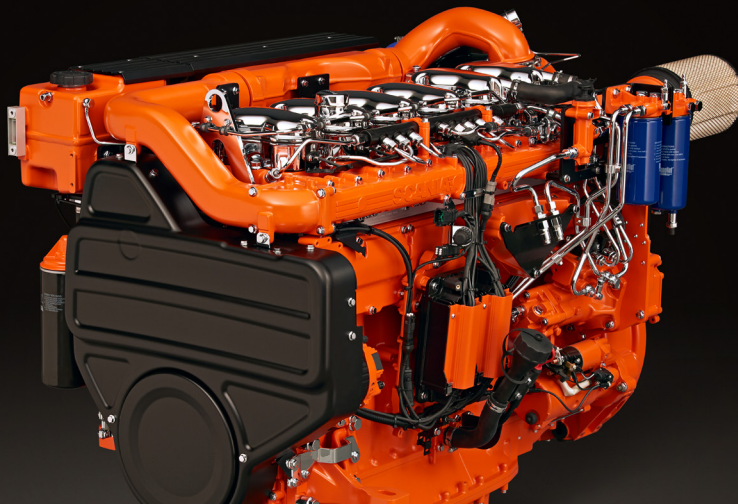

DI13 087M. 588 kW (800 hp)

US Tier 3, IMO Tier II, EU Stage IIIA



Standard equipment

- Scania Engine Management System, EMS
- Extra high pressure fuel injection system, XPI
- Turbocharger
- Fuel pre-filter with water separator
- Fuel filter
- Oil filter, full flow
- Centrifugal oil cleaner
- Oil cooler, integrated in block
- Oil filler, in engine block
- Oil dipstick, in block
- Starter, 2-pole 7.0 kW
- Alternator, 2-pole 100A
- Flywheel SAE 14
- Silumin flywheel housing, SAE 1 flange
- Front-mounted engine brackets
- Protection covers
- Closed crankcase ventilation
- Sea water pump
- Heat exchanger with expansion tank

The marine engines from Scania are based on a robust design with a strength optimised cylinder block containing wet cylinder liners that can easily be exchanged. Individual cylinder heads with 4 valves per cylinder promotes reparability and fuel economy.

The engine is equipped with a Scania developed Engine Management System, EMS, in order to ensure the control of all aspects related to engine performance. The injection system is Scania's XPI (Extra High Pressure Injection), a common rail system that gives low exhaust emissions with good fuel economy and a high torque. The engine can be equipped with many accessories such as air cleaners, PTOs, transmissions and type approved instrumentation in order to suit a variety of installations.

	Rating	Engine speed (rpm)				
		1200	1500	1800	2100	2300
Gross power, full load (kW)	Patrol craft long	324	482	560	588	588
Gross power, full load (hp, metric)		441	656	762	800	800
Gross power, propeller curve (kW)		116	202	319	468	588
Gross power, propeller curve (hp, metric)		157	275	433	637	800
Gross torque (Nm)		2578	3069	2971	2674	2441
Spec fuel consumption. Full load (g/kWh)		209	196	198	211	217
Spec fuel consumption. Propeller curve (l/h)		28	50	79	121	152
Optimum fuel consumption (g/kWh)		196				
Heat rejection to coolant (kW)		251	319	376	415	440

Patrol craft long: Intended for intermittent use where rated power is available 1 h/6 h. Between full load operations engine rpm must be reduced at least 10% from max. obtained rpm. Accumulated total service time max. 2000 h/year.

This specification may be revised without notice.



DI13 087M. 588 kW (800 hp)

US Tier 3, IMO Tier II, EU Stage IIIA

Engine description

No of cylinders	6 in-line
Working principle	4-stroke
Firing order	1 - 5 - 3 - 6 - 2 - 4
Displacement	12.7 litres
Bore x stroke	130 x 160 mm
Compression ratio	17.3:1
Weight (excl oil and coolant)	1285 kg
Oil capacity	28-34 dm ³ (standard oil sump)
Electrical system	2-pole 24V

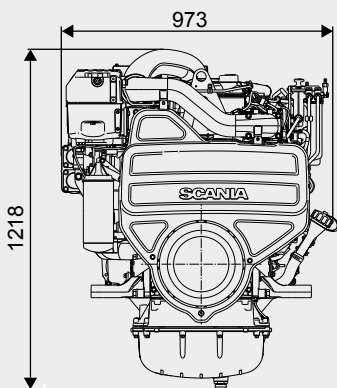
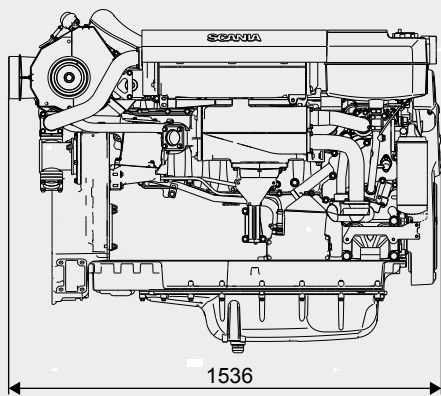

All dimensions in mm

Output

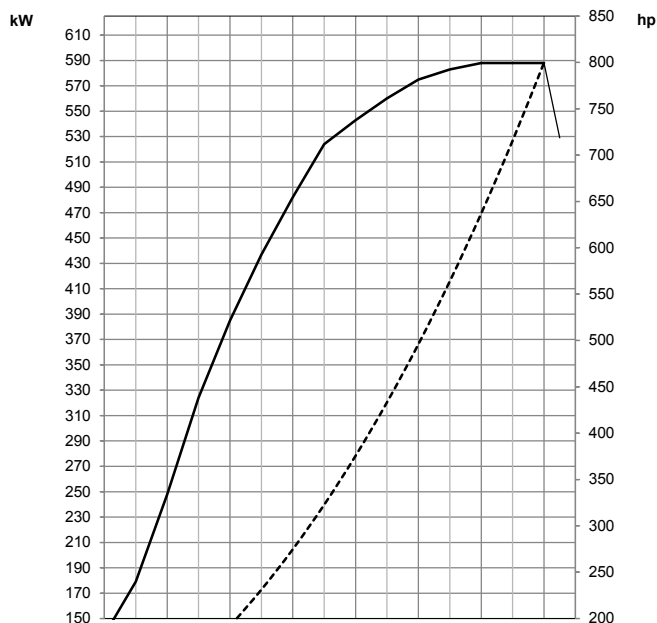

Torque

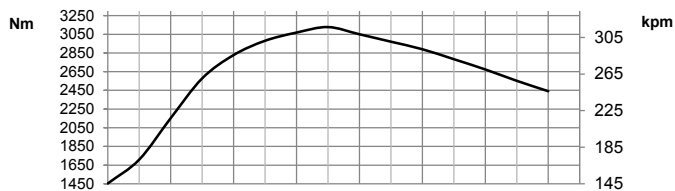

Spec fuel consumption

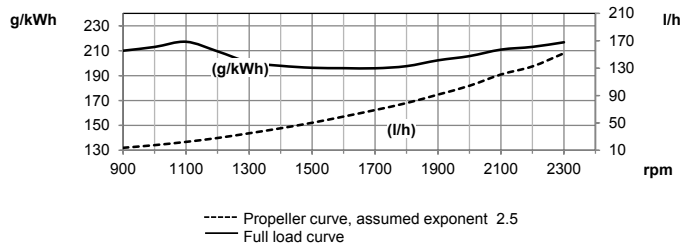

Test conditions Air temperature +25°C. Barometric pressure 100 kPa (750 mmHg). Humidity 30%. Diesel fuel acc. to ECE R 24 Annex 6. Density of fuel 0.840 kg/dm³. Viscosity of fuel 3.0 cSt at 40°C. Energy value 42700 kJ/kg. Power test code ISO 3046. Power and fuel values +/-3%.



SCANIA

SE 151 87 Södertälje, Sweden
 Telephone +46 8 553 810 00
 Telefax +46 8 553 829 93
 www.scania.com
 engines@scania.com