

# DI13 080M. 221 kW (300 hp)

US Tier 3, IMO Tier II, CCNR II

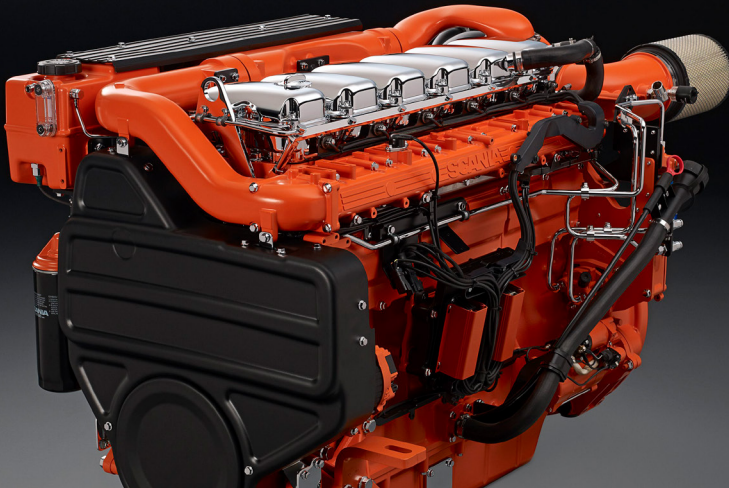

The marine engines from Scania are based on a robust design with a strength optimised cylinder block containing wet cylinder liners that can easily be exchanged. Individual cylinder heads with 4 valves per cylinder promotes reparability and fuel economy. The engines are type approved in all major classification societies.

The engine is equipped with a Scania developed Engine Management System, EMS, in order to ensure the control of all aspects related to engine performance. The injection system is based on electronically controlled unit injectors that gives low exhaust emissions with good fuel economy and a high torque already at low revs. The engine can be fitted with many accessories such as air cleaners, PTOs, transmissions and type approved instrumentation in order to suit a variety of installations.

	Rating	Engine speed (rpm)		
		1200	1500	1800
Gross power, full load (kW)	ICFN	175	210	221
Gross power, full load (hp, metric)	ICFN	238	286	300
Gross power, propeller curve (kW)	ICFN	80	140	221
Gross power, propeller curve (hp, metric)	ICFN	109	191	300
Gross torque (Nm)	ICFN	1391	1337	1172
Spec fuel consumption. Full load (g/kWh)		197	202	208
Spec fuel consumption. 3/4 load (g/kWh)		201	207	225
Spec fuel consumption. 1/2 load (g/kWh)		210	219	243
Spec fuel consumption. Propeller curve (l/h)		20	35	55
Optimum fuel consumption (g/kWh)		196		
Heat rejection to coolant (kW)		133	159	176

**ICFN – Continuous service:** Rated power available 1 h/1 h.  
Unlimited h/year service time at a load factor of 100%

### Standard equipment

- Scania Engine Management System, EMS
- Unit injectors, PDE
- Turbocharger
- Fuel pre-filter with water separator
- Fuel filter
- Oil filter, full flow
- Centrifugal oil cleaner
- Oil cooler, integrated in block
- Oil filler, in engine block
- Oil dipstick, in block
- Starter, 2-pole 7.0 kW
- Alternator, 2-pole 100A
- Flywheel SAE 14
- Silumin flywheel housing, SAE 1 flange
- Front-mounted engine brackets
- Protection covers
- Closed crankcase ventilation
- Operator's manual

### Engines with heat exchanger:

- Sea water pump
- Heat exchanger with expansion tank

### Optional equipment

- Hydraulic pump
- Side-mounted PTO
- Front-mounted PTO
- Exhaust connections
- Electrical base system
- Control and instrument panels
- Accelerator position sensor
- Engine heater
- Power pack engine bracket
- Stiff rubber suspension
- Air cleaner
- Studs in flywheel housing
- Reversible fuel filter
- Low coolant level reaction
- Variable idle speed setting
- Low and extra low oil sump
- Long oil dipstick
- Oil level sensor
- Bilge pump

This specification may be revised without notice.

# DI13 080M. 221 kW (300 hp)

US Tier 3, IMO Tier II, CCNR II

## Engine description

No of cylinders	6 in-line
Working principle	4-stroke
Firing order	1 - 5 - 3 - 6 - 2 - 4
Displacement	12.7 litres
Bore x stroke	130 x 160 mm
Compression ratio	17.3:1
Weight (excl oil and coolant)	1285 kg (Engine with heat exchanger) 1180 kg (Engine with keel cooling)
Piston speed at 1500 rpm	8.0 m/s
Piston speed at 1800 rpm	9.6 m/s
Camshaft	High position alloy steel
Pistons	Steel pistons
Connection rods	I-section press forgings of alloy steel
Crankshaft	Alloy steel with hardened and polished bearing surfaces
Oil capacity	28-34 dm <sup>3</sup> (standard oil sump)
Electrical system	2-pole 24V

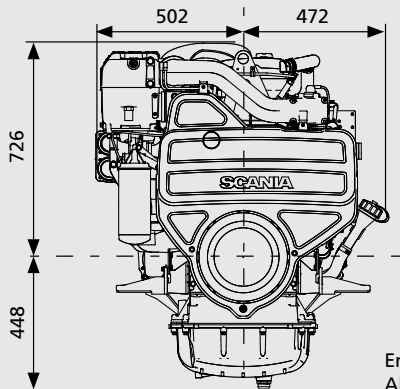
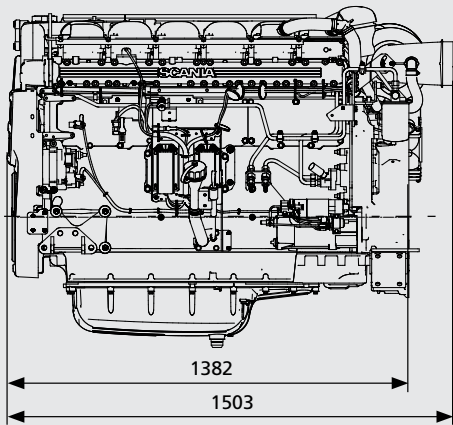

Engine with heat exchanger  
All dimensions in mm

## Output

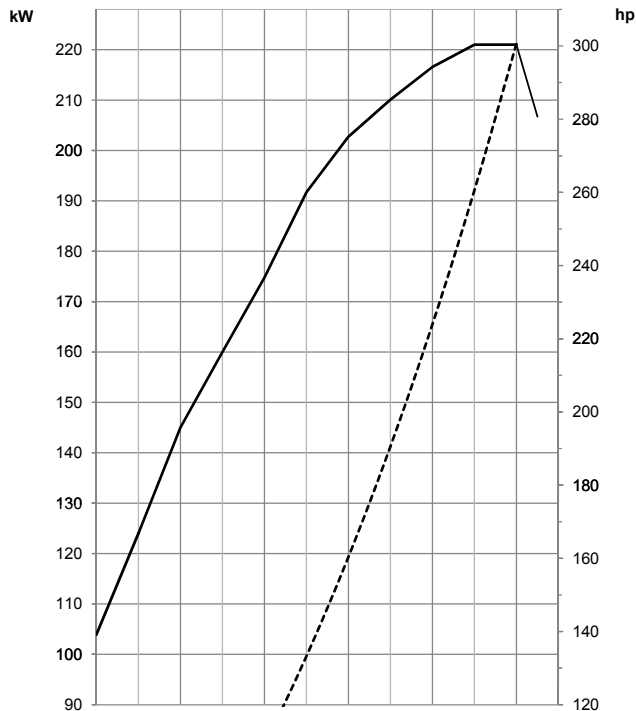

## Torque

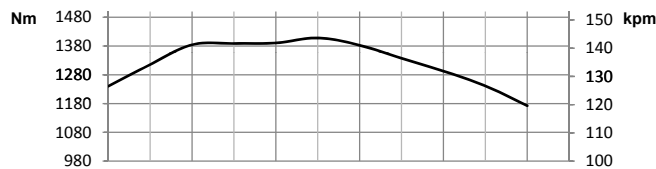

## Spec fuel consumption

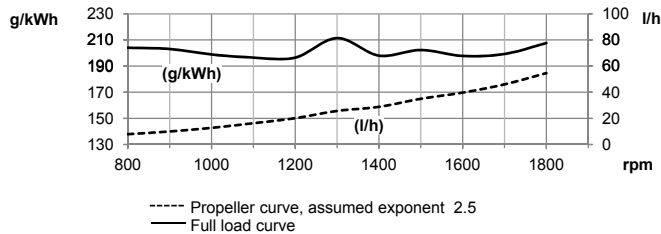

Test conditions Air temperature +25°C. Barometric pressure 100 kPa (750 mmHg). Humidity 30%. Diesel fuel acc. to ECE R 24 Annex 6. Density of fuel 0.840 kg/dm<sup>3</sup>. Viscosity of fuel 3.0 cSt at 40°C. Energy value 42700 kJ/kg. Power test code ISO 3046. Power and fuel values +/-3%.



**SCANIA**

SE 151 87 Södertälje, Sweden  
Telephone +46 8 553 810 00  
Telefax +46 8 553 829 93  
www.scania.com  
engines@scania.com